



Product availability: Stock - Normally stocked in distribution facility

Price*: 345.00 USD



Main

Range of Product	Modicon TM5
Product or Component Type	Discrete output module
Discrete output number	8
Discrete output type	Transistor

Complementary

Range Compatibility	Modicon M258 PacDrive LMC motion controller Modicon LMC058
Product Compatibility	Motion controller PacDrive LMC Pro PacDrive LMC Pro 2 Logic controller PacDrive LMC Eco
Output voltage	24 V DC
Output voltage limits	20.4...28.8 V
Discrete output logic	Source
Current per channel	2 A
Maximum current per output common	8 A
Color	White
Peak output current	12 A
Switching frequency	<= 500 Hz resistive
Response time	<= 300 µs from state 0 to state 1 output <= 300 µs from state 1 to state 0 output
Maximum leakage current	5 MA when switched off
Protection Type	Short-circuit protection Reverse polarity protection Overload protection
Isolation	No insulation between channels 500 Vrms AC insulation between channel and bus
Current consumption	0 mA 24 V DC input/output 44 mA 5 V DC bus

Maximum power dissipation in W	1.5 W
Local signalling	1 LED green for power supply 1 LED red for power supply 8 LEDs yellow output status
Electrical connection	1 wire
Marking	CE
Net Weight	0.06 Lb(US) (0.025 kg)

Environment

Standards	IEC 61131-2 CSA C22.2 No 142 CSA C22.2 No 213 UL 508
Product Certifications	CULus CSA C-tick GOST-R
Ambient air temperature for operation	14...131 °F (-10...55 °C) without derating horizontal installation) 14...140 °F (-10...60 °C) with derating factor horizontal installation) 14...122 °F (-10...50 °C) vertical installation)
Ambient Air Temperature for Storage	-40...158 °F (-40...70 °C)
Relative Humidity	5...95 % without condensation
IP degree of protection	IP20IEC 61131-2
Pollution degree	2 IEC 60664
Operating altitude	0...6561.68 ft (0...2000 m)
Storage altitude	0.00...9842.52 Ft (0...3000 m)
Vibration resistance	1 gn 8.4...150 Hz DIN rail 3.5 mm 5...8.4 Hz DIN rail
Shock resistance	15 gn 11 ms
Electromagnetic compatibility	Electrostatic discharge immunity test, 4 kV on contact EN/IEC 61000-4-2 Electrostatic discharge immunity test, 8 kV in air EN/IEC 61000-4-2 Susceptibility to electromagnetic fields, 1 V/m 2...2.7 GHz EN/IEC 61000-4-3 Susceptibility to electromagnetic fields, 10 V/m 80...2000 MHz EN/IEC 61000-4-3 Electrical fast transient/burst immunity test, 1 kV I/O EN/IEC 61000-4-4 Electrical fast transient/burst immunity test, 1 kV shielded cable EN/IEC 61000-4-4 Electrical fast transient/burst immunity test, 2 kV power lines EN/IEC 61000-4-4 1.2/50 µs shock waves immunity test, 0.5 kV differential mode EN/IEC 61000-4-5 1.2/50 µs shock waves immunity test, 1 kV common mode EN/IEC 61000-4-5 Conducted RF disturbances EN/IEC 61000-4-6 Conducted and radiated emissions CISPR 11

Ordering and shipping details

Category	22532 - M258 PLC
Discount Schedule	PC12
GTIN	03595864074658
Nbr. of units in pkg.	1
Package weight(Lbs)	1.41 Oz (40 g)
Returnability	Yes
Country of origin	AT

Packing Units

Unit Type of Package 1	PCE
Package 1 Height	0.24 In (0.6 cm)
Package 1 width	0.79 In (2 cm)
Package 1 Length	4.33 In (11 cm)

Offer Sustainability

Sustainable offer status	Green Premium product
California proposition 65	WARNING: This product can expose you to chemicals including: Lead and lead compounds, which is known to the State of California to cause cancer and birth defects or other reproductive harm. For more information go to www.P65Warnings.ca.gov
REACH Regulation	REACH Declaration
REACH free of SVHC	Yes
EU RoHS Directive	Pro-active compliance (Product out of EU RoHS legal scope) EU RoHS Declaration
Toxic heavy metal free	Yes
Mercury free	Yes
RoHS exemption information	Yes
China RoHS Regulation	China RoHS Declaration
Environmental Disclosure	Product Environmental Profile
Circularity Profile	End Of Life Information
WEEE	The product must be disposed on European Union legal markets following specific waste collection and never end up in rubbish bins.
PVC free	Yes

Contractual warranty

Warranty	18 months
----------	-----------

TM5 Slice

Dimensions



TM5 System

Spacing Requirements

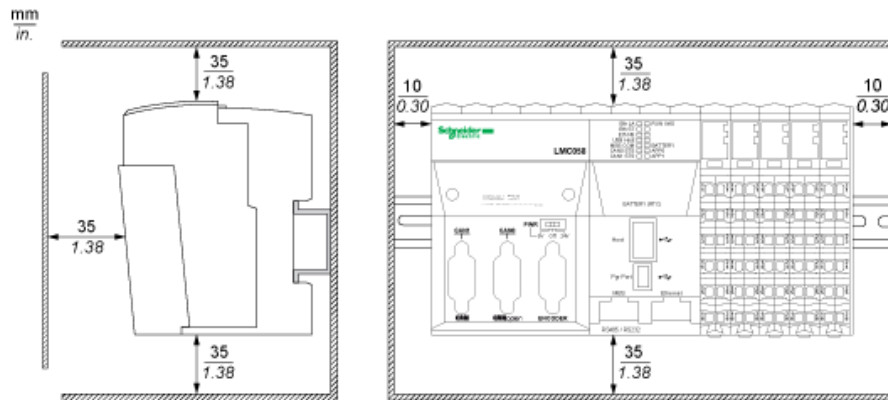



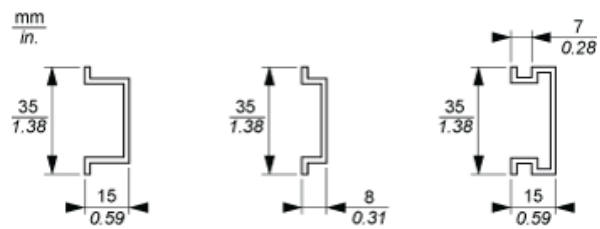

Mounting on a DIN Rail



TM5 System Wiring Recommendations

Wire Sizes to Use with the Removable Spring Terminal Blocks

mm in.				
mm ²	0,08...2,5	0,25...2,5	0,25...1,5	2 x 0,25...2 x 0,75
AWG	28...14	24...14	24...16	2 x 24...2 x 18

Electronic Module 8DO 24 Vdc Tr 2 A 1 Wire

Wiring Diagram

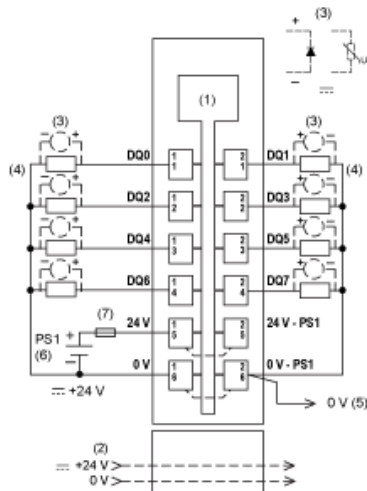

- (1) Internal electronics
- (2) 24 Vdc I/O power segment integrated into the bus bases
- (3) Inductive load protection
- (4) 2-wire load
- (5) 0 Vdc I/O power segment by external connection
- (6) PS1: External isolated SELV power supply 24 Vdc limited to 200 VA for UL 508 conformance, or limited to 150 VA for CSA 22.2, N° 142 conformance
- (7) External fuse, Type T slow-blow 8 A max., 250 V

Product Life Status : **Commercialised**